

# COMMERCIAL CONTAINER DIMENSIONS

## Frontload Containers

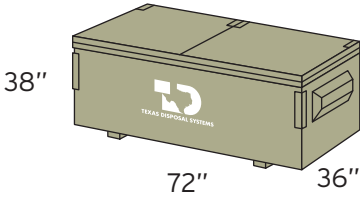

2 Cubic Yard

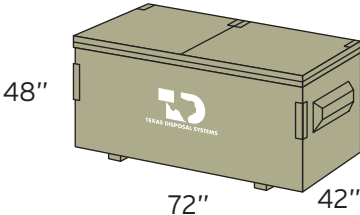

3 Cubic Yard

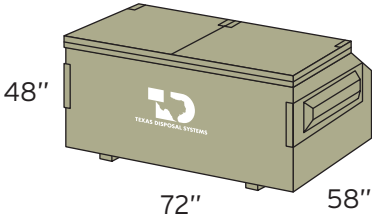

4 Cubic Yard

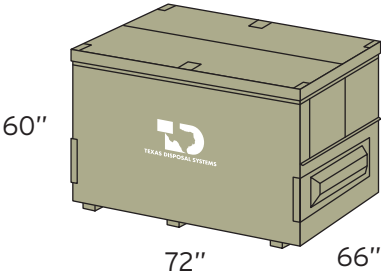

6 Cubic Yard

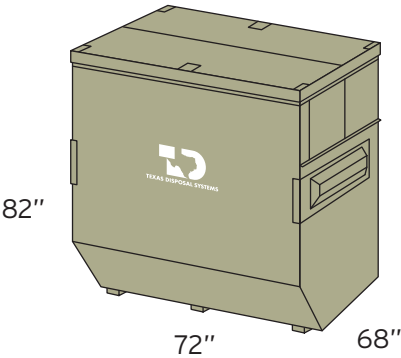

8 Cubic Yard

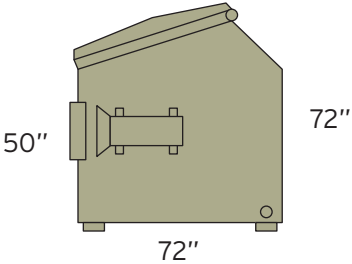

6 Cubic Yard Slant

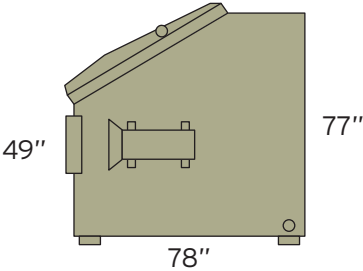

8 Cubic Yard Slant



For a free consultation with a Commercial Specialist, please contact  
800.375.8375 or [solutions@texasdisposal.com](mailto:solutions@texasdisposal.com) | [www.texasdisposal.com](http://www.texasdisposal.com)

## Sideload Containers

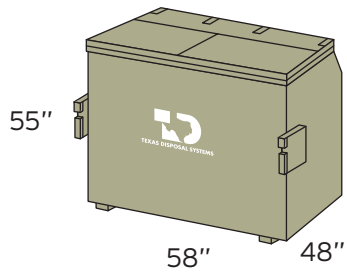

3 Cubic Yard

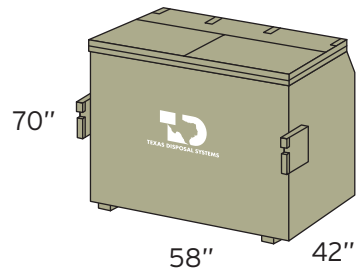

4 Cubic Yard

## Roll-Off Containers

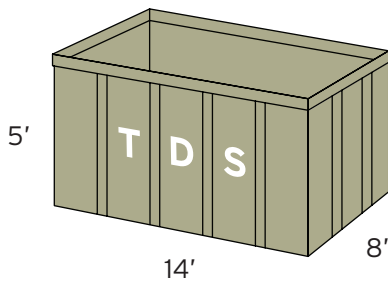

14 Cubic Yard

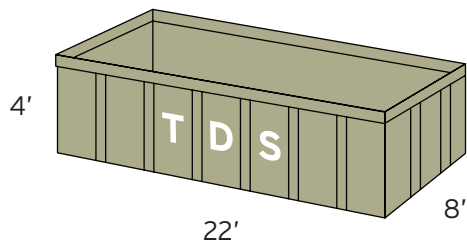

20 Cubic Yard

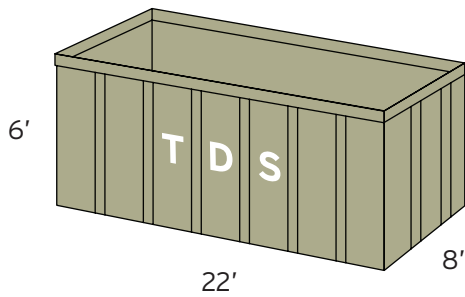

30 Cubic Yard

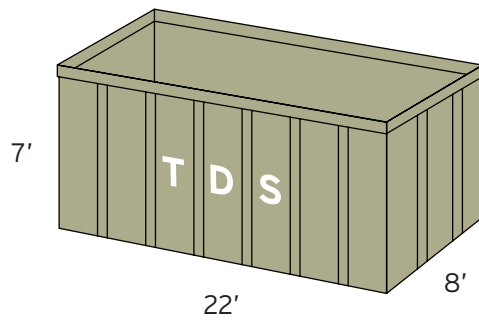

40 Cubic Yard



For a free consultation with a Commercial Specialist, please contact  
800.375.8375 or [solutions@texasdisposal.com](mailto:solutions@texasdisposal.com) | [www.texasdisposal.com](http://www.texasdisposal.com)